

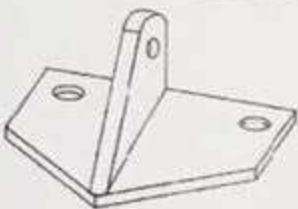

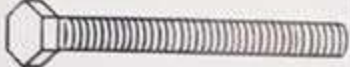







ROOF TOP TENT

MANUAL

02 ROOF TOP TENT HARDWARE IDENTIFICATION CHART

Part name	Quantity (pcs)	Image
Ladder Mounting Bracket	2	
55 mm Steel M8 Bolt	8	
40 mm Steel M6 Bolt	4	
35 mm Steel M6 Bolt	4	
16 mm Steel Bolt To Mount Ladder M6	2	
Stainless Steel Mount Plate	4	
Aluminium Slide Plate	8	
M6 Nylock Nut	10	
M8 Nylock Nut	8	
Stainless Steel Washer	8	
Tool	3	
Mounting Channel	2	

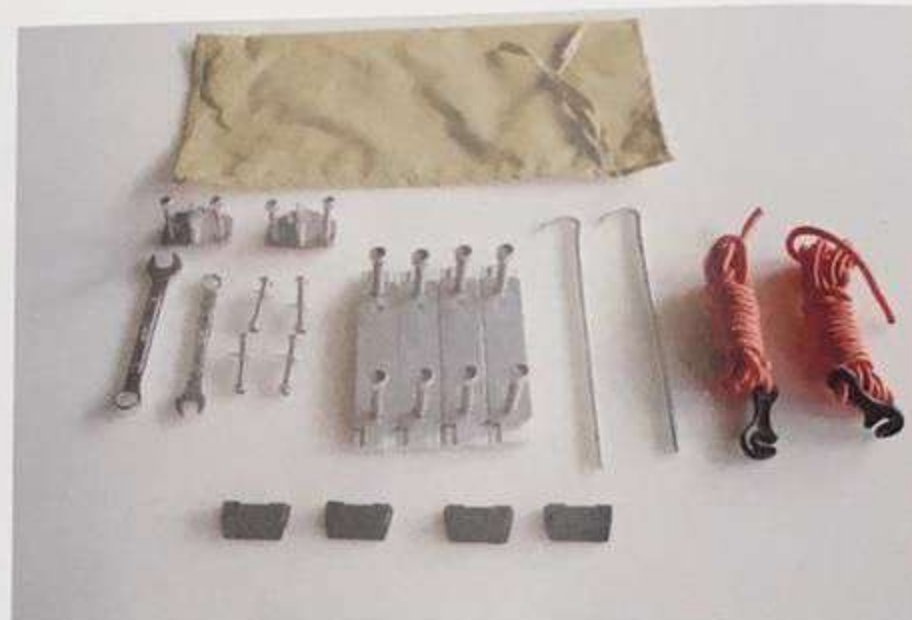

03 TENT ORIENTATION ON YOUR VEHICLE

There are two mounting options for the orientation of your new Roof Top Tent. Either the Roof Top Tent will open so that the ladder extends off the back of your vehicle, "Rear Mounted". Or alternatively the ladder extends off the side of your vehicle, "Side Mounted". Either orientation will work for larger vehicles, however, most sedans or smaller SUV are better suited for the side mounted option. If the Roof Top Tent is side mounted, the mounting channels need to be cut to match the width of the Roof Top Tent base.



Thank You for Purchasing Our Roof Top Tent

Congratulations on you getting a Roof Top Tent. We strive to provide the ultimate camping experience. Your Roof Top Tent mounts directly to your roof rack or aftermarket roof bars. The tent can be opened and set up in just a few minutes. Your Roof Top Tent is made of durable materials and high quality rip-stop fabrics that provide excellent water and wind resistance.

Most of your Roof Top Tent components have been fully assembled at factory expect for attaching channels and ladder to the base. So tent setup is composed of unpacking, attaching channels and ladder to the base, attaching the tent cover, mounting your tent onto the roof rack or aftermarket roof bars, setting up windows and doors.

During setting up and first use, you may find some Aluminum swarf inside of your Roof Top tent. We make every possible attempt to expel and vacuum all Aluminum swarf, however, with vibrations caused by logistics, some may reappear.

PLEASE READ ALL INSTRUCTIONS BEFORE INSTALLING

Please thoroughly read the instructions and warnings set forth in this manual.

1 WARNING

Improper installation or use of your Roof Top Tent may result in serious injury or death. You will need to follow these installation instructions carefully to ensure proper installation on your vehicle and safe use of your Roof Top Tent. Please contact your vehicle manufacturer for specified loading capacity of your roof rack. Not all factory roof racks or aftermarket roof bars can safely accommodate all tent models.

Any elements applied on the vehicle roof changes the normal vehicle handling. The manufacturer disclaims all responsibility in case of accidents due to improper use, improper maintenance, or checking the tightness of the brackets regarding the installation of the roof rack system.

Inspections:

1. During trips regularly check that all nuts and bolts in your Roof Top Tent to your vehicle are tight and in good repair. This includes hinges, ladder and mounting track .
2. Before package or closing ,please inspect the whole tent and make sure the tent is dry enough . This includes the fabric ,base, ladder and cover .

For your safety and protection, ensure correct placement and angle of ladder.

DO NOT CLIMB ON LADDER UNTIL CORRECT ANGLE IS ACHIEVED (approx. 60 degrees Between ladder and ground).

NOTE: If the angle of the ladder is at 90 degrees and / or does not reach the ground, you will need a ladder extension or longer extendable ladder .

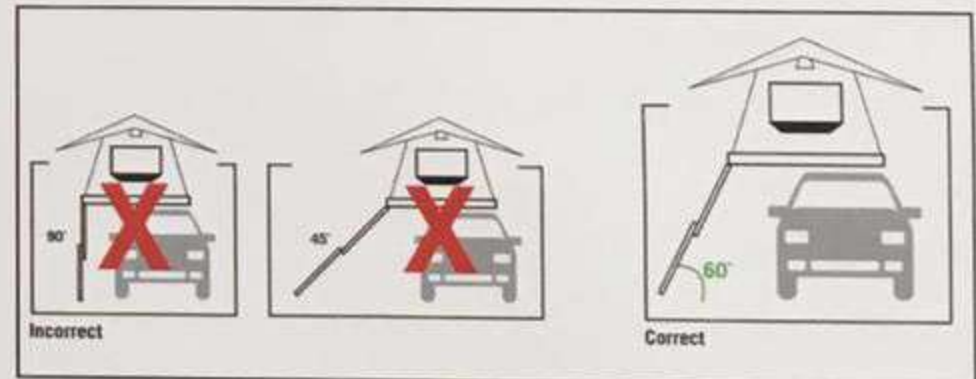

SAFETY WARNING

KEEP ALL FLAME AND HEAT SOURCES AWAY FROM THE TENT MATERIALS. UNDER NO CIRCUMSTANCE SHOULD ANY NAKED FLAME SOURCES OR HEATING DEVICES BE USED INSIDE OR NEAR THE TENT. KEEP CAMP FIRES WELL AWAY FROM TENT.

KEEP A LOOK OUT FOR ANY AIRBORNE BURNING EMBERS THAT MAY COME INTO CONTACT WITH THE TENT.

KEEP A FIRE EXTINGUISHER OR WATER BUCKET NEARBY. DO NOT SMOKE WITHIN THE TENT.

DO NOT OPERATE ANY DEVICE WHICH BURNS FUEL INSIDE OF THE TENT. KEEP EXIT CLEAR.

04 ATTACHING MOUNTING CHANNELS

1. Remove the Roof Top Tent from the carton and place on a clean surface. Observe the top surface. If it has four holes in the center area of the base, then this is the side which will receive the mounting channels. Otherwise you are looking at the surface which will receive the ladder. Open tent to gain entrance to interior and remove contents.

Contents:

Ladder/s – 1 pcs, PVC cover – 1 pcs, Rod for window – 6/8 pcs,
Mounting channel – 2 pcs, Mounting accessories – 1 bag.

2. After removing the contents, close the Roof Top Tent, so the channel mounting surface is facing upward, then find the holes (side with 4 holes).

3. Using the four supplied 40mm Steel M6 bolt, slide your hand between the base and mattress, and insert the bolts with washers into the pre-drilled holes.

4. Place mounting channels on exposed bolts. For side mounted orientation, ensure the mounting channels are perpendicular to hinge side. For rear mounted orientation, ensure the mounting channels are parallel to hinge side.

5. Slide the M6 Nylock Nut into the inner slot in the center of the mounting channels, until they are aligned with the bolts sticking through the base. Tighten the bolts firmly from below, using the supplied 10mm wrench. If you chose a side mounted orientation, you will notice that the mounting channels extend beyond the edges of the base. You will need to mark each channel where they extend beyond the tent base and cut the mounting channels so they fit within the tent base. Fasten mounting channels to base as described above.

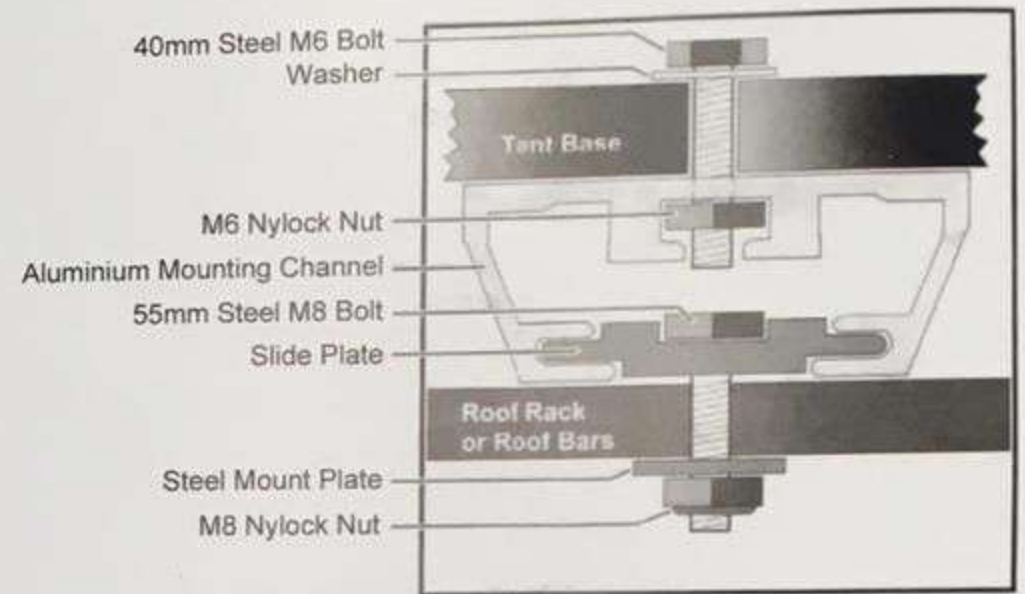

DIAGRAM A

05 ATTACHING THE LADDER

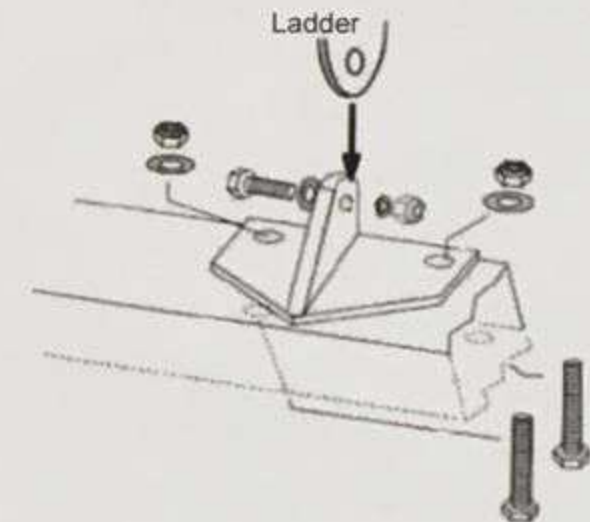

DIAGRAM B

1. Flip the tent base over.
2. Locate the pre-drilled holes at the edge of the base and attach the ladder bracket to the base using 35mm Steel M6 bolt, washers, and nylock nuts.

06 FITTING THE ROOF TOP TENT TO YOUR ROOF RACK

1. Place the Roof Top Tent on top of your vehicle's roof rack system. (minimum 2 persons required).
2. Place 55mm Steel M8 bolt into the slide plates. Slide the plates and bolts into the mounting channel. You will need to lift a Roof Top Tent side, so as to have one of the bolts on the inside of the roof rack bar.
3. Inspect the position of Roof Top Tent to ensure it is centered on the roof rack and positioned to open the desired side.

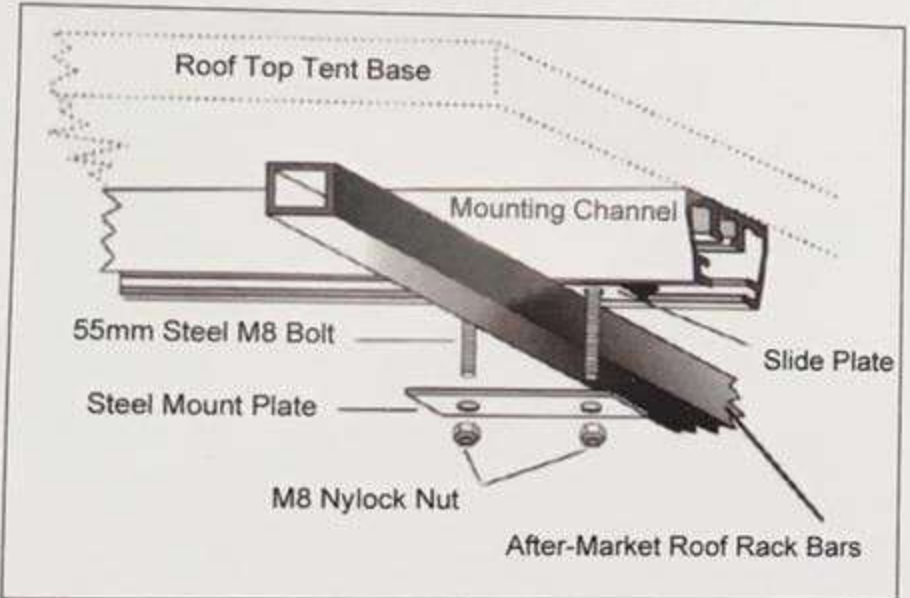

DIAGRAM D

4. Attach the Roof Top Tent to your roof rack at the four points where the rack and mounting channels cross. Tighten all eight bolts securely. It is important that you check all the mounting bolts and brackets periodically to ensure they are securely fastened to your base and roof rack or after-market roof bars.
5. After ensuring the Roof Top Tent is positioned correctly, and all eight bolts are tightened securely, insert the rubber end caps into the ends of the mounting channel (this may require light taps from a hammer).

07 CLOSING AND STORAGE

Use ladder as lever to close tent. Press down the top folded base to close tent completely. Slide ladder back to storage position. Use Velcro straps to hold bases in dosed position.

Caution:

- Do not pull down on Velcro straps when dosing the tent. Excessive force on Velcro straps will cause damage to your tent.
- Avoid storing your tent wet. Please set up tent and dry the whole tent as soon as possible to avoid moisture damage.
- The overall height of your vehicle is increased when driving with your rooftop tent. Please avoid any overhead barrier to damage the tent cover.
- The centre of gravity is altered when the rooftop tent is fitted to your vehicle. Adjust your driving to accommodate this change.

08 WARRANTY

Warranty

We offer a 1-year manufactures warranty on all roof top tents. We will repair or replace any damage or faults that arise due to a manufacturing defect. This warranty does not cover damage caused by the user. The warranty is only valid if the safety and fitting instructions are followed properly. If you're out of warranty, well still help, see below!

Repairs

We have spare parts, and pretty much everything on the tent is interchangeable, so even if a tent is out of warranty, or has been damaged by a user, we will send you parts to fix as quickly and as affordably as possible. In this option, small parts can be free charge, but you need to under take the cost of big parts and freight cost.